

Date of Purchase ___ / ___ / ___
Lot Number:

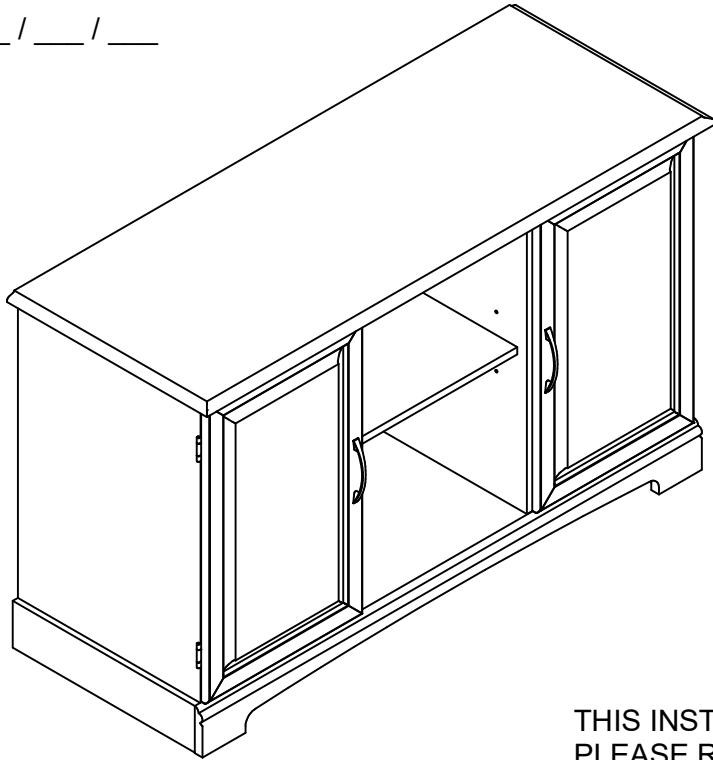

DO NOT RETURN PRODUCT TO THE STORE
Individual stores do not stock parts.

NO REGRESAS ESTA PRODUCTO A LA TIENDA
Las tiendas no tiene partes.

NE RETOURNEZ PAS LE PRODUIT AU MAGASIN
Les magasins individuels ne gardent pas de pièces.

If a part is missing or damaged, please visit our website or call our toll-free customer service line. We will gladly ship your replacement parts **FREE** of charge.

Si las partes están perdidas o dañadas Por favor visite nuestra página de Internet o llame a nuestra línea de teléfono gratis de Servicio al Cliente. Nosotros le enviaremos sus repuestos sin cargo adicional, serán totalmente gratis.

Si une pièce est manquante ou endommagée, veuillez visiter notre site web ou appelez sans frais notre Service à la clientèle. Nous expédierons avec plaisir vos pièces de rechange **GRATUITEMENT**.

Need Parts or Assistance?	Nesacitas partes o Asistencia?	Besoin de Pièces ou d'assistance?
---------------------------	--------------------------------	-----------------------------------

WWW.AMERIWOODHOME.COM/PARTS

or call toll free:
o llame a nuestra línea gratis: 1-800-489-3351
ou appelez sans frais:

For prompt, reliable service; please have your assembly manual ready.
Para servicio mas rapido y reliable por favor tenga esta manual listo.
Pour un service rapide et fiable, s'il vous plaît ayez votre livret d'assemblage en main.

THIS INSTRUCTION BOOKLET CONTAINS **IMPORTANT** SAFETY INFORMATION.
PLEASE READ AND KEEP FOR FUTURE REFERENCE.

-KEEP FOR REFERENCE-

-GUARDAR PARA REFERENCIA-

-GARDEZ POUR RÉFÉRENCE-

	<p>▲ WARNING</p> <p>Unit can tip over causing severe injury or death.</p> <ul style="list-style-type: none"> ● Anchor unit to stud or wall. ● DO NOT allow children to climb on unit. ● Put heavy items on lower shelves or drawers. ● Read and follow all assembly instructions. 	<p>▲ ADVERTENCIA</p> <p>Este mueble puede caerse por encima causando daño serio o la muerte</p> <ul style="list-style-type: none"> ● Anolar el mueble a un espárrago muro. ● NO dejar que los niños suben por encima del mueble. ● Poner los articulos mas pesados en los tableros o cajones inferiores. ● Leer y seguir todos de los instucciones para el montaje. 	<p>▲ AVERTISSEMENT</p> <p>L'unité peut basculer et causer des blessures graves ou la mort.</p> <ul style="list-style-type: none"> ○ Fixez l'unité au mur ou à un montant. ○ Ne laissez PAS les enfants grimper sur le meuble ○ Déposez les pièces lourdes sur les tablettes ou tiroirs du bas. ○ Lire et suivre toutes les instructions d'assemblage.
--	---	---	---

Thank you for purchasing from AMERIWOODHOME.

Visit www.ameriwoodhome.com to view the limited warranty valid in the U.S. and Canada.

AMERIWOODHOME CONSUMER SERVICES

Gracias por haber comprado en AMERIWOODHOME.

Visite www.ameriwoodhome.com para ver la garantía limitada válida solamente en Estados Unidos y Canadá.

SERVICIO A LA CLIENTELA EN AMERIWOODHOME

AMERIWOODHOME vous remercie de votre achat.

Visitez www.ameriwoodhome.com pour voir la garantie limitée valide au Canada et aux États-Unis.

SERVICE À LA CLIENTÈLE
D'AMERIWOODHOME

Before starting – Antes de empezar – Avant de débiter.



- Read each step carefully before starting. It is very important that each step is performed in the correct order. If these steps are not followed in sequence, assembly difficulties will occur.

Lea con cuidado cada paso antes de empezar. Es muy importante que cada paso se ejecute en el orden correcto, de lo contrario, tendrá dificultades en el ensamblaje.

Lisez chaque étape soigneusement avant de commencer. Il est très important que chaque étape de l'assemblage soit exécutée dans le bon ordre. Si ces étapes ne sont pas suivies dans l'ordre, vous aurez de la difficulté à assembler le meuble.

- Make sure all parts are included. Most board parts are labeled or stamped on the raw edge. *Asegúrese de tener todas las piezas. Cada pieza está marcada con una etiqueta o con un sello en el lado sin acabado.*

Assurez-vous que toutes les pièces sont incluses. La plupart des pièces en bois sont étiquetées ou estampées sur le bord non fini.

- Work in spacious area, preferably on a carpet, near the place the unit will be used. *Ejecute el ensamblaje en un área espaciosa, de preferencia sobre una alfombra y cerca del lugar donde se usará el mueble.*

Travaillez dans un endroit spacieux, préféablement sur un tapis, près de l'endroit où le meuble sera utilisé.

- Have the following tools. *Tenga las siguientes herramientas a mano.*

Ayez les outils suivants à la portée de la main.

- Do not use power tools to assemble your furniture. Power tools may strip or damage the parts. *No use herramientas eléctricas para ensamblar el mueble. Las herramientas eléctricas pueden raspar o dañar las piezas.*

N'utilisez pas d'outils électriques pour assembler le meuble, car ceux-ci peuvent endommager les pièces.

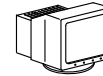
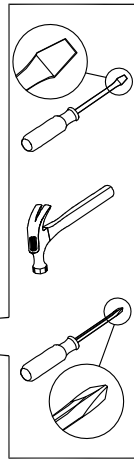

Visit our website:

Visite nuestra página de internet:

Visitez notre site Web:

WWW.AMERIWOODHOME.COM/PARTS



Call us at:

Llame al:

Téléphone:

1-800-489-3351



Fax:

Facsimil:

Télécopieur:

1-888-315-8745



Write to:

Escriba a:

Adresse:

AMERIWOODHOME

410 East First Street South
Wright City, MO 63390 USA
Attention: Consumer Services

Monday – Friday
9:00 am – 5:00 pm
Central Time

Lunes – Viernes
9:00 am – 5:00 pm
Horario Central

Lundi – Vendredi
9:00 am – 5:00 pm
Heure normale du Centre

HELPFUL HINTS

- Visit our website for basic assembly tips and to order replacement parts.
- Identify, sort and count the parts before attempting assembly.
- Call our toll free number if you need assistance identifying parts.
- Compression dowels are tapped in with a hammer.
- Slides have lips only on the right side.
- Cam locks that are properly fastened on a horizontal board will face toward the center of the unit, on a vertical board the point on the lock will face the bottom.
- Back panels provide stability and support. Use all the nails provided.
- When nailing back panels to the unit, be sure there is equal distance on all sides to square the unit.
- Units without the back panel installed may collapse.
- Clean the product with your favorite furniture polish and a soft cloth. DO NOT USE harsh chemicals or abrasive cleaners.
- Move your new furniture carefully, with two people lift and carry the unit to a new location.
- Never push, pull or drag your furniture (especially on carpet).
- Additional parts are available for a nominal fee.

NOTIAS UTILES

- Visite nuestra página de internet para que siga los pasos básicos del montaje del mueble y ordene las piezas que necesitan ser reemplazadas.
- Identifique, clasifique y cuente todas las piezas antes de empezar el ensamblaje.
- Llame gratis al número de servicio al cliente si necesita ayuda con el identificación de las piezas.
- Las clavijas de compresión se golpean con un martillo.
- Las correderas solo tienen un borde en el lado derecho.
- Las cerraduras de leva que están correctamente sujetadas a un tabla horizontal estarán orientadas hacia el centro de la unidad; en una tabla vertical, la cerradura apuntará hacia el lado inferior.
- Los paneles traseros dan estabilidad al mueble. Use todos los clavos incluidos.
- Cuando clava paneles traseros a la unidad, procure que haya una distancia igual en todos los lados para cuadrar la unidad.
- Los muebles que no tienen el panel trasero pueden colapsar.
- Limpie el producto con su abrillantador para muebles favorito y un paño suave. NO USE químicos fuertes ni limpiadores abrasivos.
- Mueva su mueble nuevo con mucho cuidado y con la ayuda de otra persona levante y mueva el mueble a su lugar.
- Nunca empuje, jale o arrastre un mueble (especialmente sobre una alfombra).
- Por un pago nominal puede ordenar piezas adicionales.

NOTES UTILES

- Visitez notre site Web pour obtenir des conseils de montage de base et pour commander des pièces de rechange.
- Identifiez, séparez et comptez les pièces avant d'entreprendre l'assemblage.
- Appelez à notre numéro sans frais si vous avez besoin d'aide pour identifier les pièces.
- On insère les goujons au moyen d'un marteau.
- Les glissières ont des rebords seulement sur le côté droit.
- Les cames installées correctement sont orientées vers le centre pour ce qui est des planches horizontales, et vers le bas pour ce qui est des planches verticales.
- Les panneaux arrière stabilisent et soutiennent le meuble. Utilisez tous les clous fournis.
- En enfonçant les clous dans une planche, assurez-vous que toutes les distances entre les coins sont égales pour que le meuble soit à l'équerre.
- Certaines parties du meuble peuvent s'écrouler si elles ne sont pas fixées au panneau arrière.
- Nettoyez le meuble avec votre poli à meubles préféré et un linge doux. NE PAS UTILISER de produits chimiques ou de nettoyants abrasifs.
- Déplacez votre nouveau meuble avec soin, avec l'aide d'une autre personne et portez-le jusqu'à son nouvel emplacement.
- Ne jamais pousser ou traîner votre meuble (surtout sur un tapis).
- Il est possible d'obtenir des pièces supplémentaires à peu de frais.

PARTS - PIEZAS - PIECES

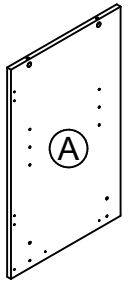

left panel
panel izquierdo
panneau gauche
3509333011

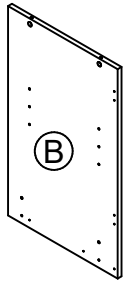

right panel
panel derecho
panneau droit
3509333021

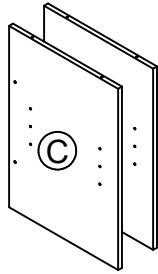

2 partitions
2 particiónes
2 cloisons
3509333030

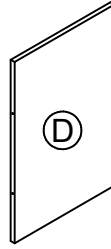

center rear panel
panel del centro trasero
pan du centre arrière
3509333040

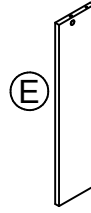

left rear panel
panel trasero izquierdo
pan arrière gauche
3507333051

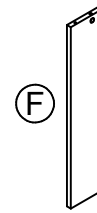

right rear panel
panel trasero derecho
pan arrière droit
3507333061

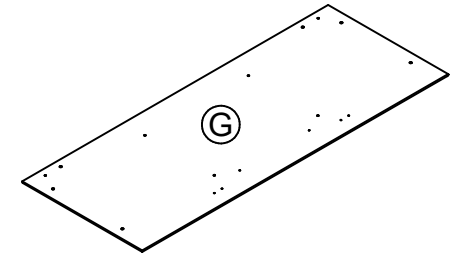

top
cima
dessus
3509333071

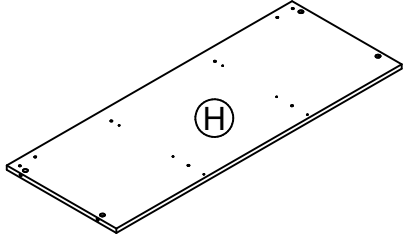

bottom
fondo
fond
3509333081

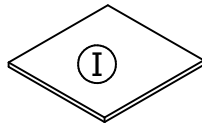

center adjustable shelf
tablero ajustable del centro
tablette ajustable du centre
3509333090

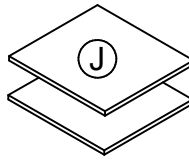

2 side adjustable shelves
2 tableros ajustable de lado
2 tablettes ajustable de côté
3509333100

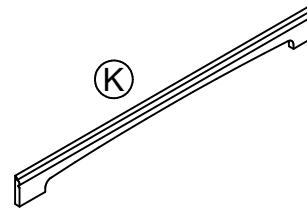

front skirt
barra de frente
barreau avant
3509333111

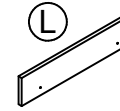

left side skirt
barra izquierdo
barreau gauche
3509333121

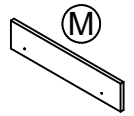

right side skirt
barra derecho
barreau droit
3509333131

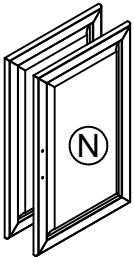

2 doors
2 puertas
2 porrtes
3509333141

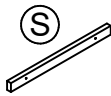

valance
valencia
valence
3509333190

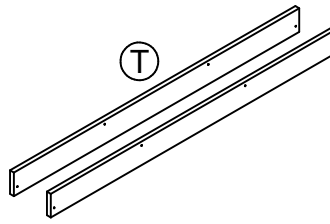

2 supports
2 soportes
2 supports
3509333201

PARTS - PIEZAS - PIECES

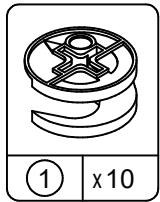

① x10
#A22620
cam lock
cerradura de leva
serrure de came

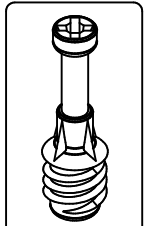

② x 10
#A22610
cam bolt
perno de leva
boulon de came

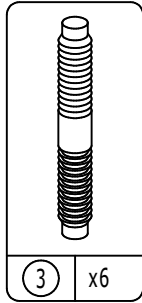

③ x6
#A21520
compression dowel
clavija de compresion
goujon de compression

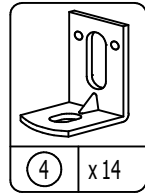

④ x14
#A53600
angle bracket
anaquel del ángulo
support de l'angle

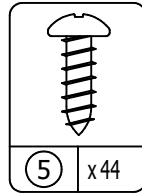

⑤ x44
#A12210
1/2" pan head
cabeza redondo 1/2"
tête ronde

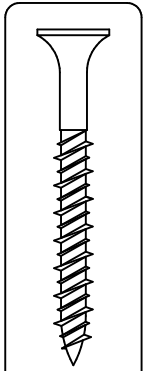

⑥ x12
#A13410
1 3/4" flat head
cabeza plano 1 3/4"
tête plate 1 3/4"

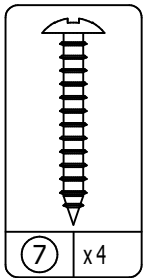

⑦ x4
#A12850
1" pan head
cabeza redondo 1"
tête ronde 1"

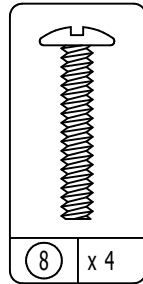

⑧ x4
#A17400
machine screw
tornillo
vis

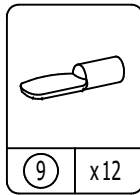

⑨ x12
#A80250
shelf support
soporte de tablero
support de la tablette

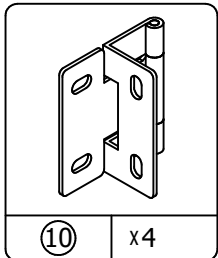

⑩ x4
#A60010
hinge
bisagra
charnière

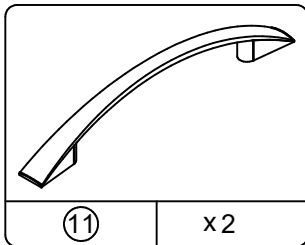

⑪ x2
#A52395
handle
manija
poignée

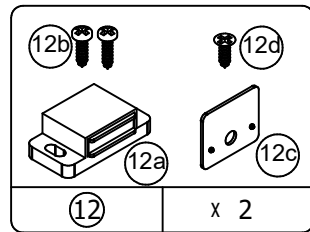

⑫ x2
#A31000
magnetic catch kit
equipo de la captura magnético
ensemble de loquet magnétique

This illustration shows how the CAM fastening system works.
Esta ilustración muestra el sistema de fijación de leva y como funciona.
Cette illustration montre le système de fixation CAME et son fonctionnement.

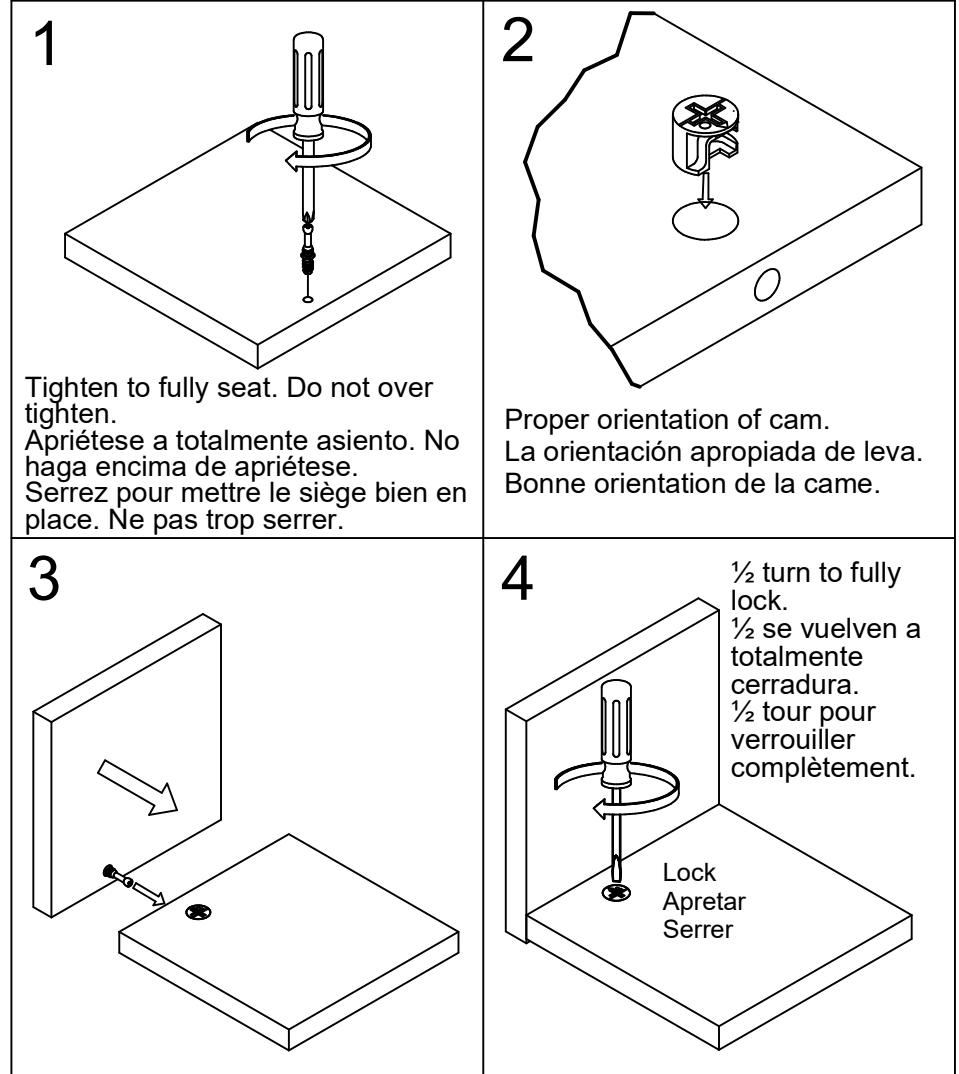

1

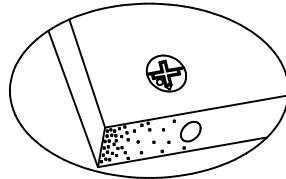
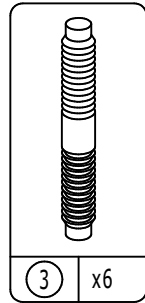
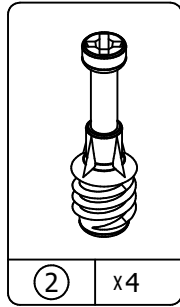
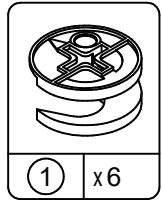

Proper orientation of CAM LOCK
Posición correcta de la cerradura de leva.
Bonne orientation de la SERRURE DE CAME

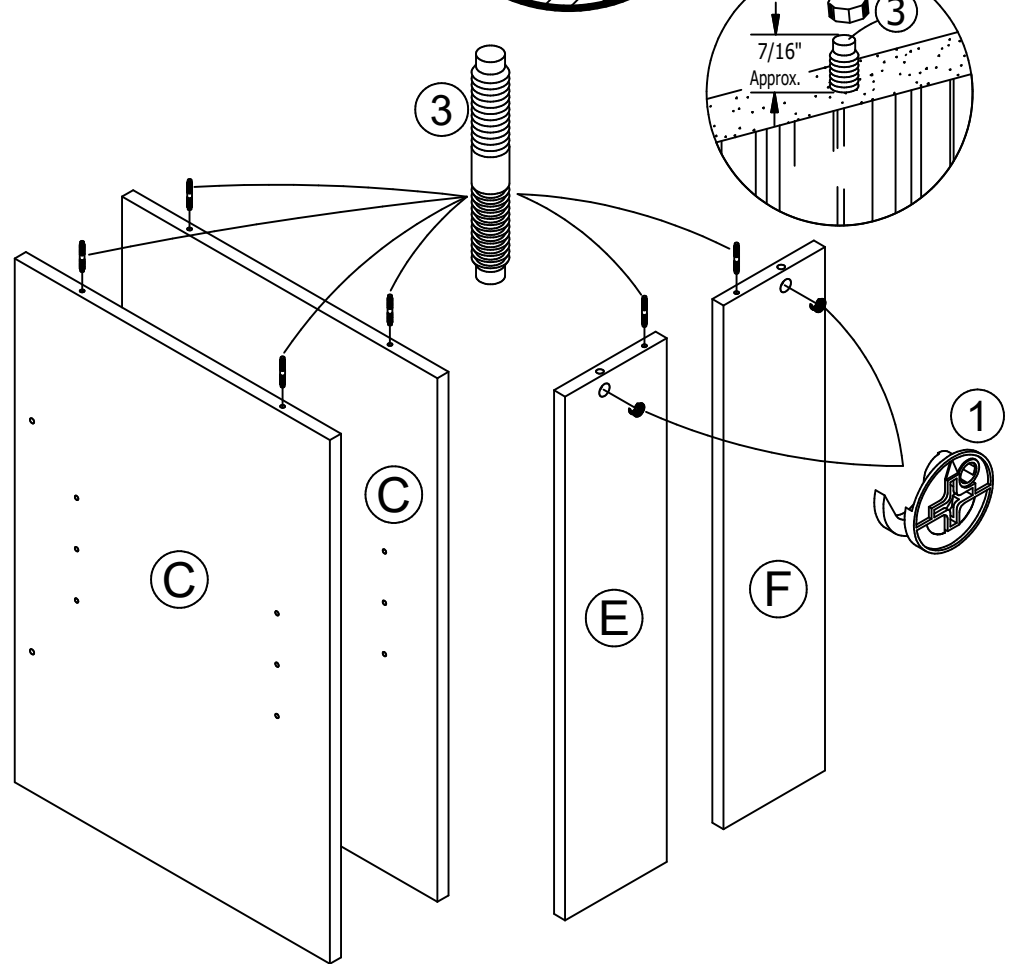
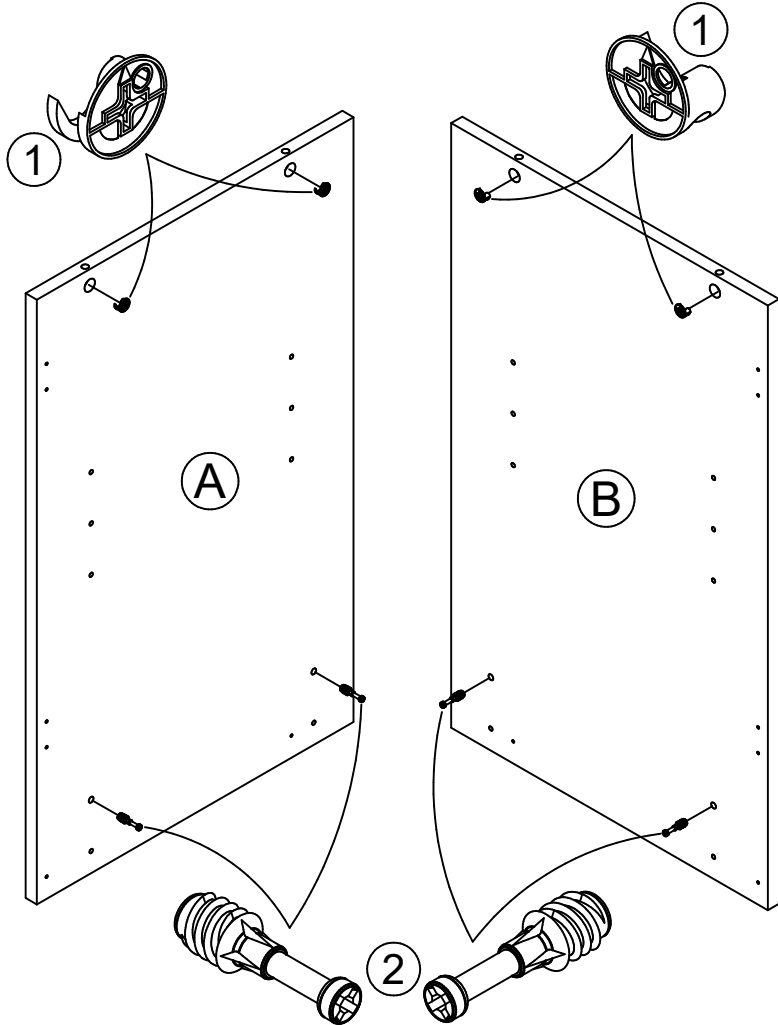
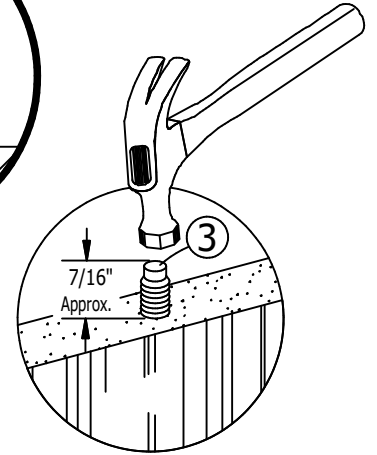
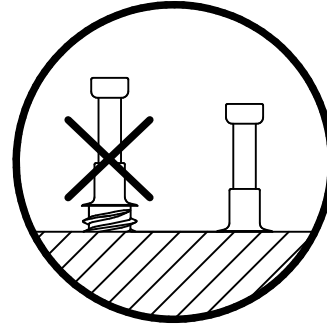

2

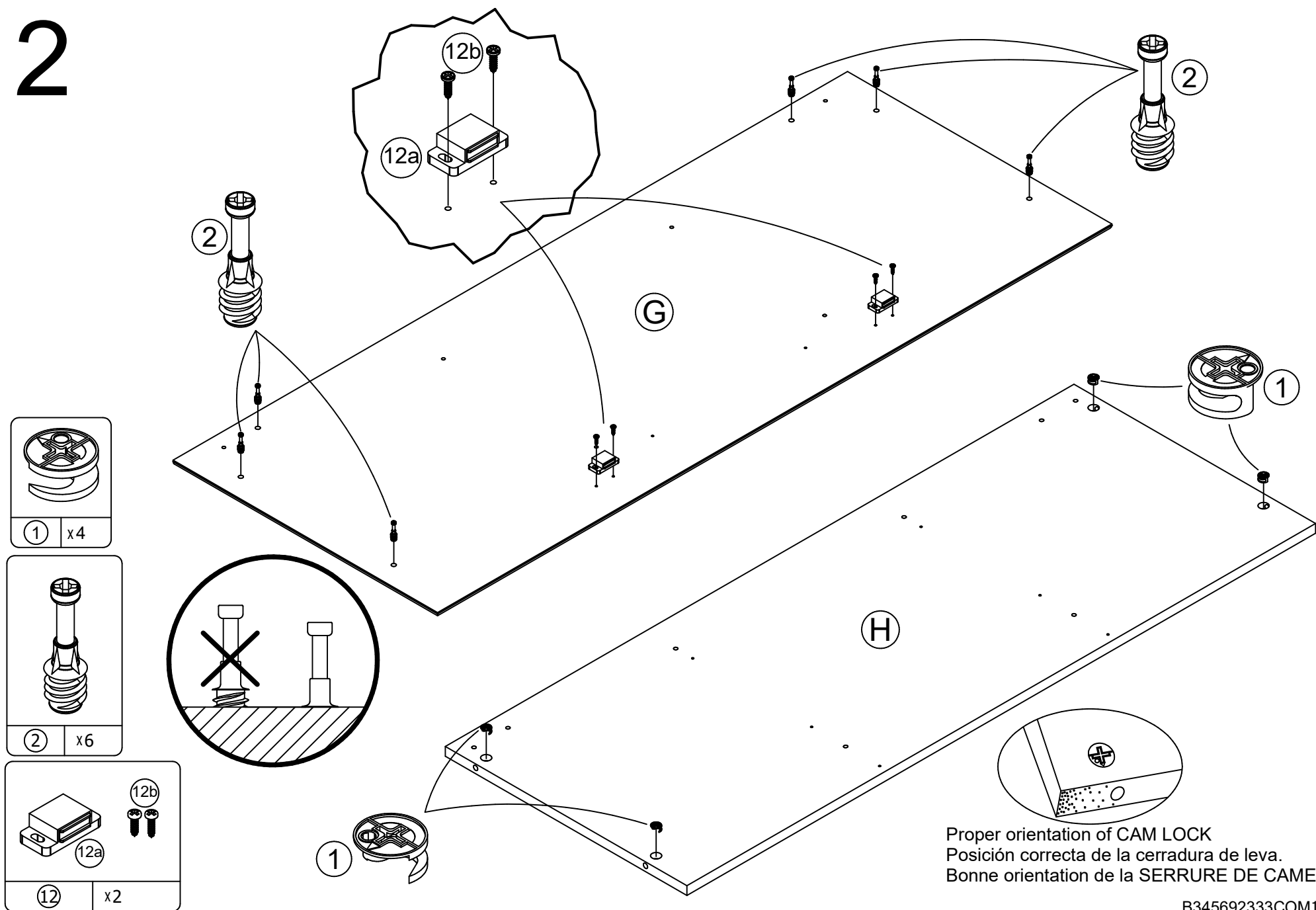

Proper orientation of CAM LOCK
Posición correcta de la cerradura de leva.
Bonne orientation de la SERRURE DE CAME

3

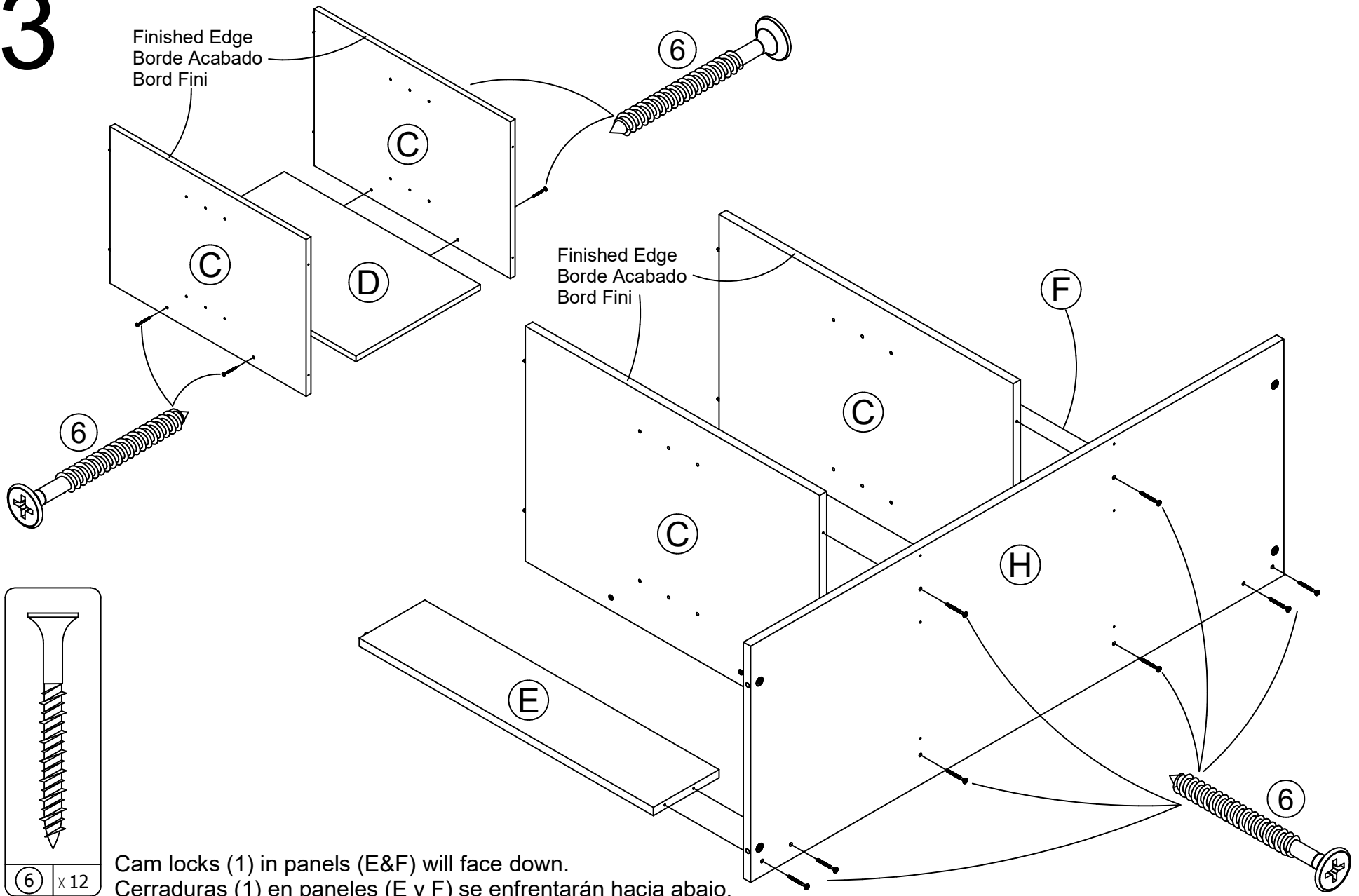

Cam locks (1) in panels (E&F) will face down.
Cerraduras (1) en paneles (E y F) se enfrentarán hacia abajo.
Verrous de Cam (1) dans des panneaux (E et F) devra faire face vers le bas.

⑥ x 12

4

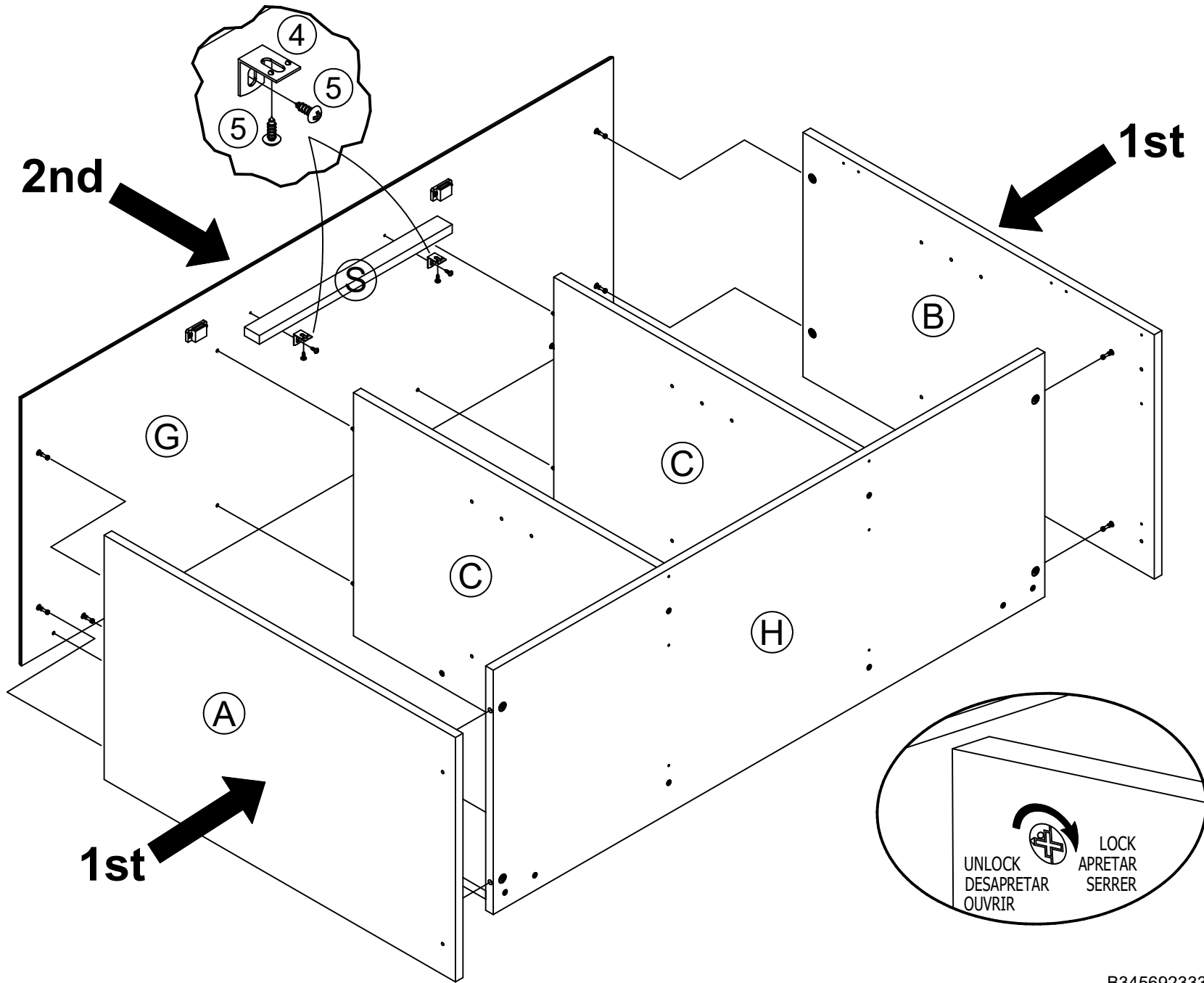
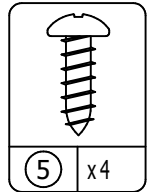
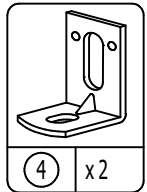

5

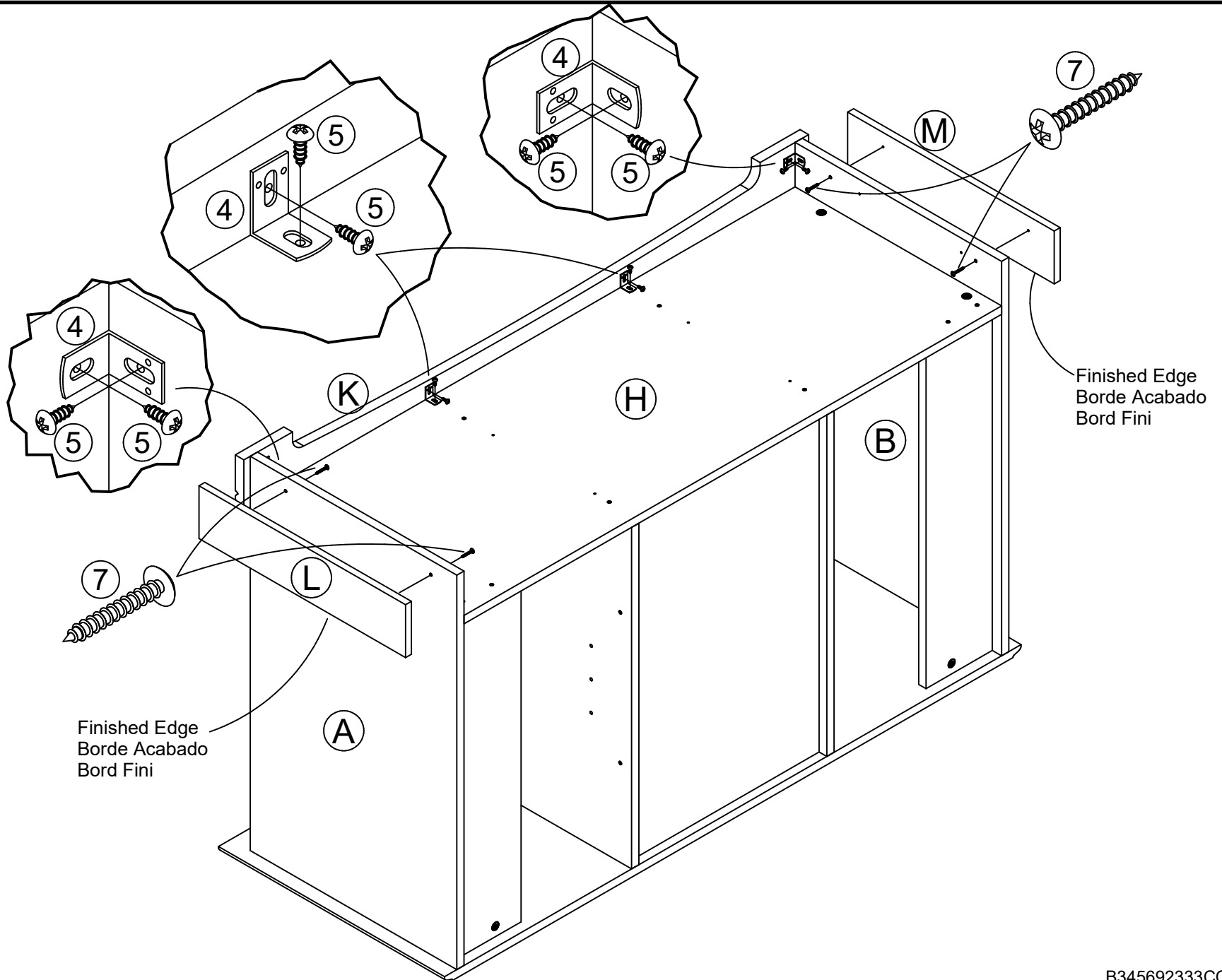
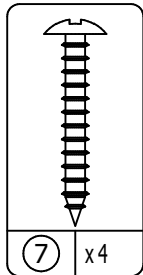
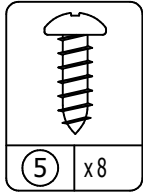
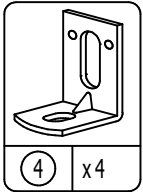

6

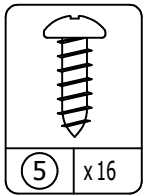
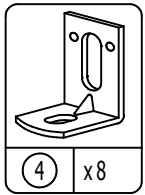
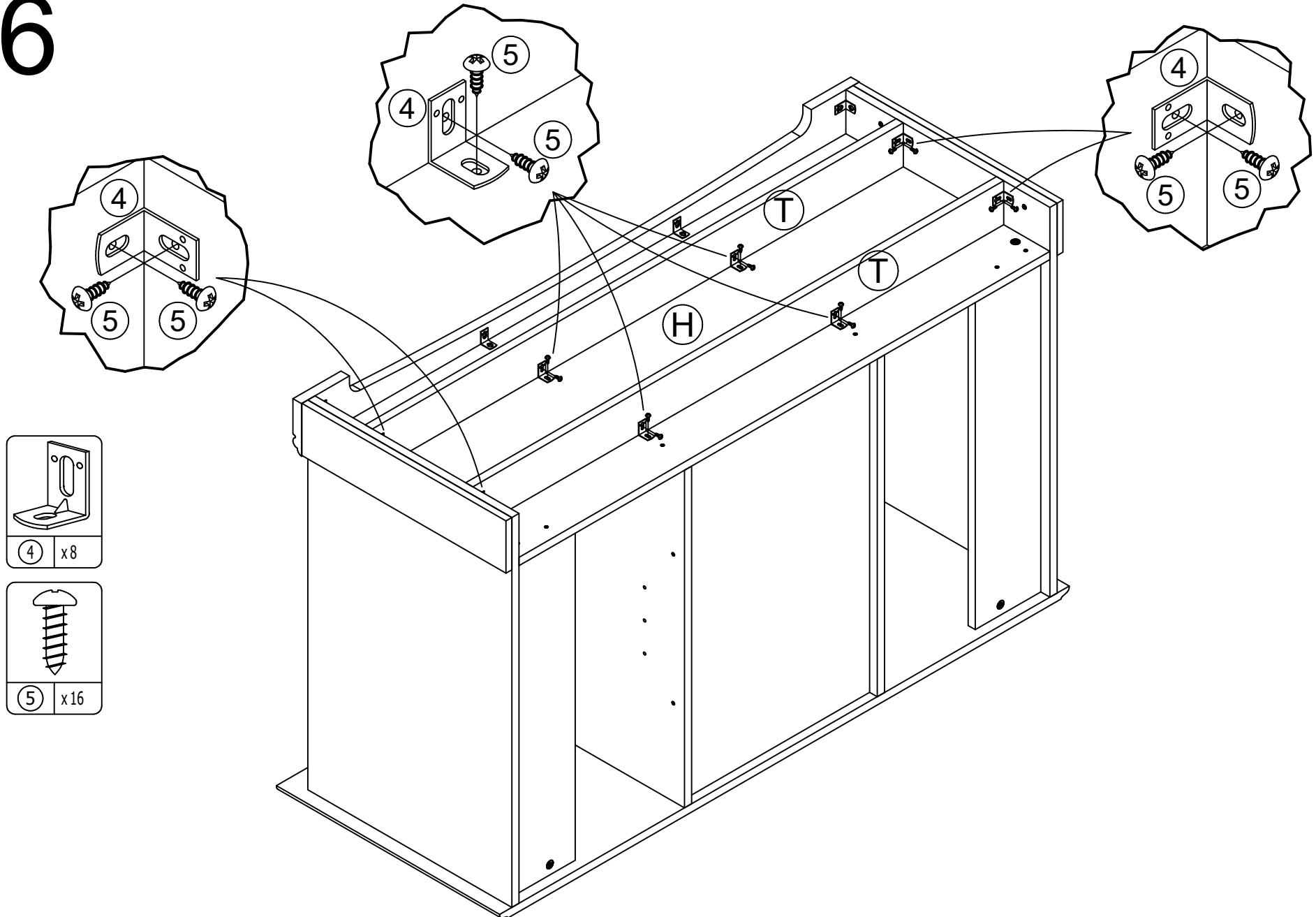

7

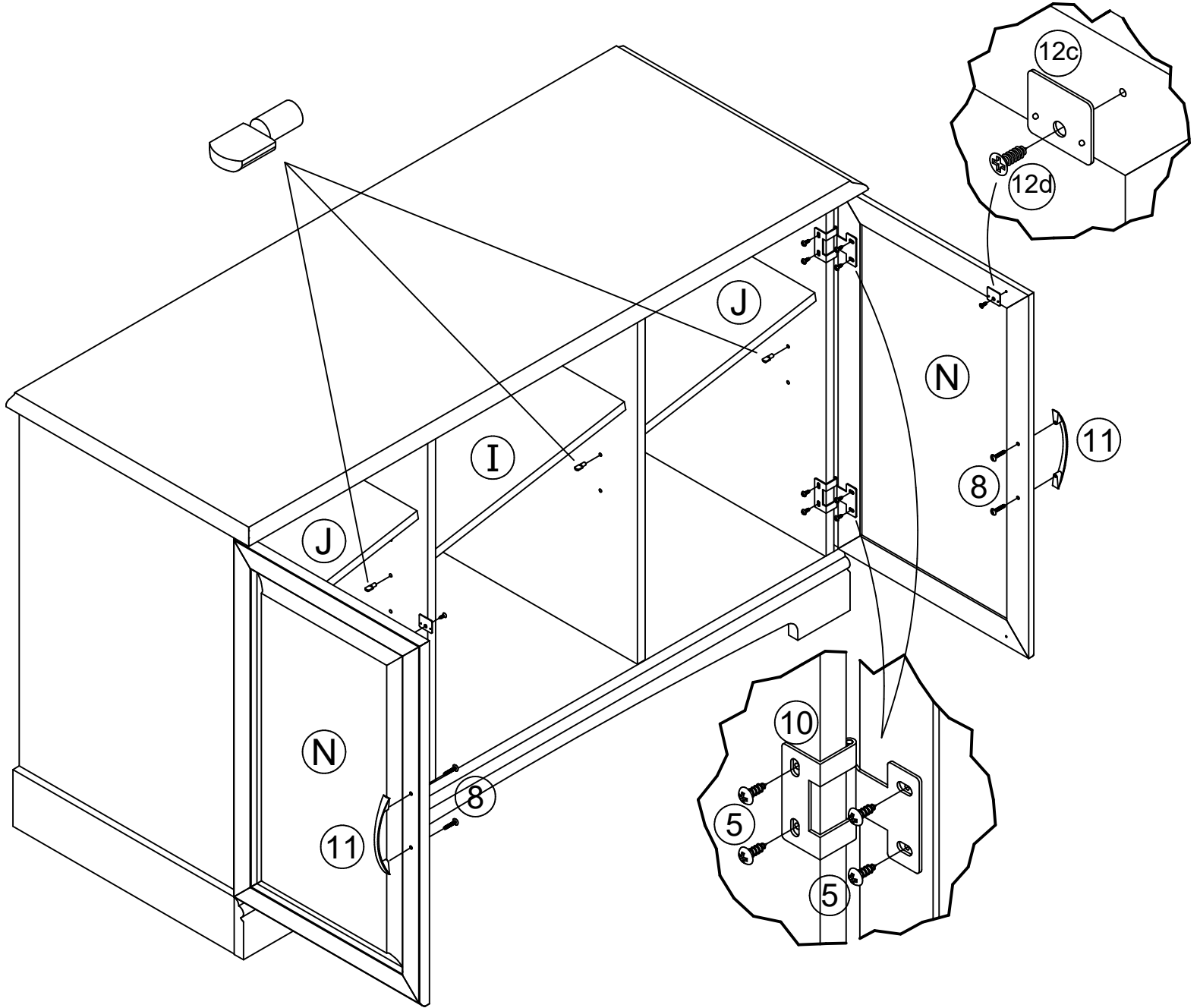
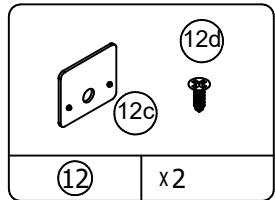
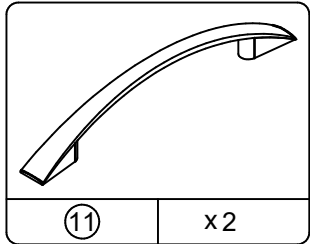
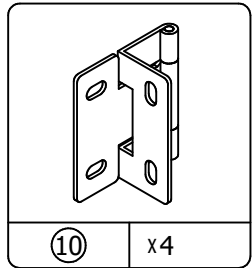
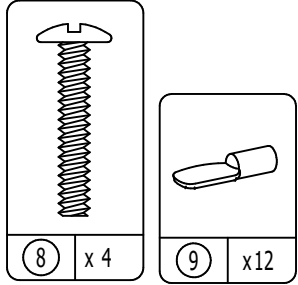
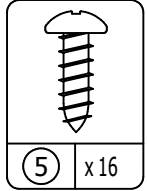

MAXIMUM LOADS – CARGA MAXIMA - CHARGES MAXIMALES

This unit has been designed to support the maximum loads shown. Exceeding these load limits could cause sagging, instability, product collapse, and/or serious injury.

Esta unidad ha sido diseñada para soportar la carga máxima anotada. El exceder estos límites puede causar inestabilidad, colapsarse y/o causar serias lesiones.

Ce meuble a été conçu pour supporter les charges maximales indiquées. En excédant ces limites de charge, le meuble pourrait devenir instable, s'effondrer, et/ou causer des blessures graves.

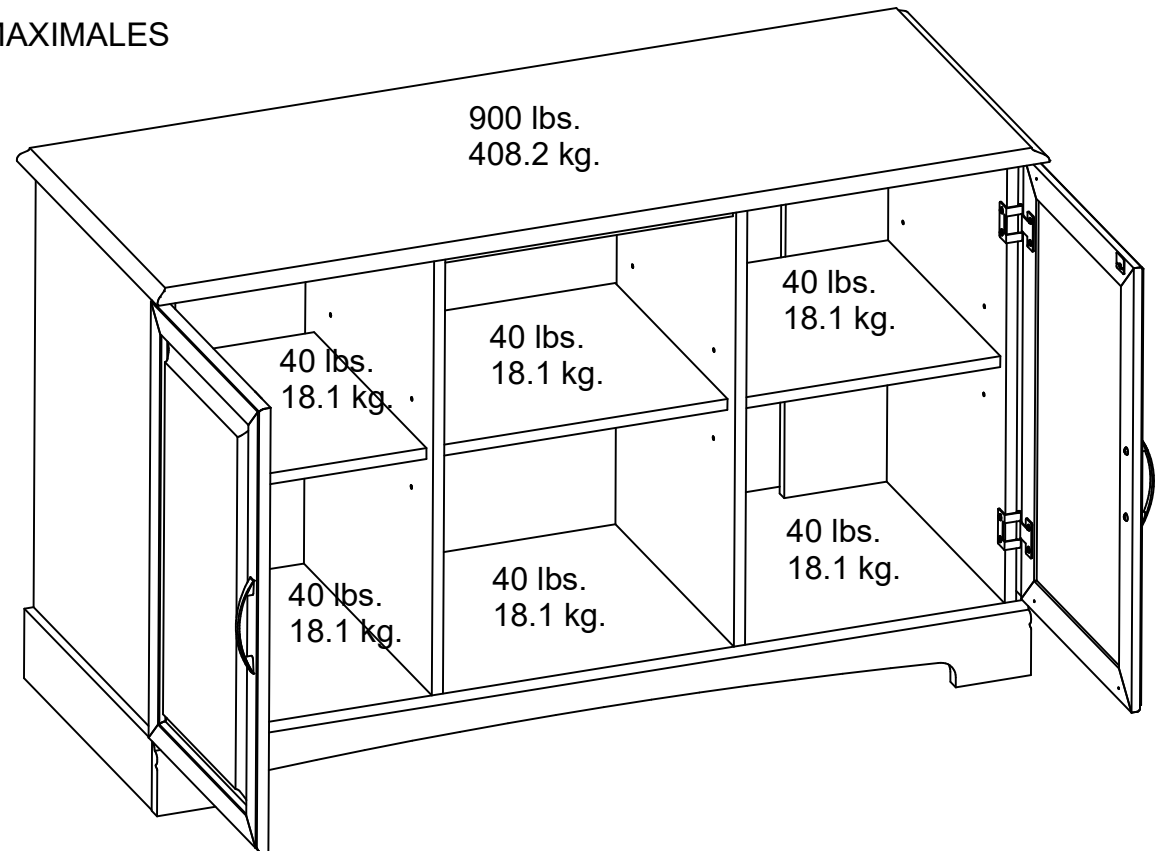

Certificate of Conformity

1. This certificate applies to the Dorel Home Furnishings, Inc. product identified by this instruction manual.
2. This certificate applies to compliance of this product with the CPSC Ban on Lead-Containing Paint (16 CFR 1303).
3. This product is distributed by: Dorel Home Furnishings, Inc.

410 East First Street South
Wright City, MO 63390
636-745-3351

4. Site of Manufacture:
 Dowagiac MI

5. See front page of instruction manual for date of manufacture.